

CATALOGO PRODOTTI

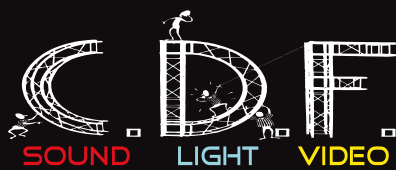





# INDICE

	CDF - l'azienda	p. 3
	Clienti	p. 1
	I nostri lavori	p. 5
illuminazione		p. 7
	Quadri elettrici	p. 29
	Tralicci	p. 33
	Varie	p. 37

# IMAGE IS EV

Vinitaly Verona; Abitami Milano; Summer Jambooree Senigallia; Luxury Vicenza; Sigep Rimini; Moda Parigi;  
Senigallia; Palazzo Corsini di Firenze; Festival di Venezia; Fiera Autopromotec Bologna; Palazzo Venezia;

# EVERYTHING

Moda Milano; **Motor Show Bologna**; **Salone del mobile di Milano**; Eicma moto Milano; Fiera Campionaria di Expo Riva Schuh Riva del Garda; Palazzo Venezia; **Autopromotec Bologna**; ...

C.D.F. SRL

Via dell'Industria, 31  
61040 Monteporzio (PU)  
Tel 0721 955566  
Fax 0721 955566

[www.cdftecnologie.it](http://www.cdftecnologie.it)  
[info@cdftecnologie.it](mailto:info@cdftecnologie.it)

## C.D.F. S.r.l

### L'IMMAGINE E' TUTTO

CDF, sinonimo di garanzia e affidabilità. Azienda leader nel settore fieristico e non, con esperienza ventennale, operativa in tutto il mondo. Grazie alla collaborazione con le più grandi aziende, la CDF è cresciuta consolidando una clientela prestigiosa e fedele.

Lo staff è composto da professionisti che con la loro dinamicità sono in grado di offrire un servizio completo che va dall'installazione alla disinstallazione soddisfacendo qualsiasi necessità, anche quelle delle clientela più esigente. Grazie alle nostre linee guida, serietà e competenza, sono molte le aziende che si sono affidate alla nostra professionalità.













ILLUMINAZIONE



FARETTO AD INCASSO  
ALOGENO - LED  
ORIENTABILE, ø 80 mm



FARETTO AD INCASSO  
ALOGENO - LED  
ORIENTABILE, ø 115 mm



FARETTO AD INCASSO  
ALOGENO - LED  
FISSO, ø 67 mm



FARETTO AD INCASSO  
ALOGENO - LED  
FISSO, ø 60 mm



FARETTO CALPESTABILE  
ALOGENO,  $\varnothing$  60 mm



FARETTO INCASSO  
PER SOFFITTI,  $\varnothing$  160mm



FARETTO CALPESTABILE  
A SCARICA, 80 x 80 mm



FARETTO CALPESTABILE  
LED,  $\varnothing$  80 mm



STELO DICROICO SU BINARIO



FARETTO A BRACCIO SEMICURVO DICROICO - LED



ARCHETTO DICROICO SU BINARIO CON FILTRO



FARETTO - SCINTILLA CON STELO



FARETTO A BRACCIO  
CON DOPPIO SNODO  
HALOSPOT, Ø 111mm



FARETTO - SCINTILLA



SPOT A BINARIO  
CON PARABOLA  
Nero



SPOT A BINARIO  
CON PARABOLA  
Bianco



FARO KANCO CON STELO  
ALOGENO O LED



SPOT TARGETTI  
SU BINARIO



FARETTO ALOGENO -GABBIANO-  
SU BINARIO O BASETTA



FARO -GABBIANO-  
SU BINARIO O BASETTA  
HALOSPOT, R 111





FARO ALOGENO ELLITTICO  
SU BINARIO



MINI-SAGOMATORE SU BINARIO  
DIMMERABILE



MINI-SAGOMATORE A LUCE DIRETTA  
DIMMERABILE

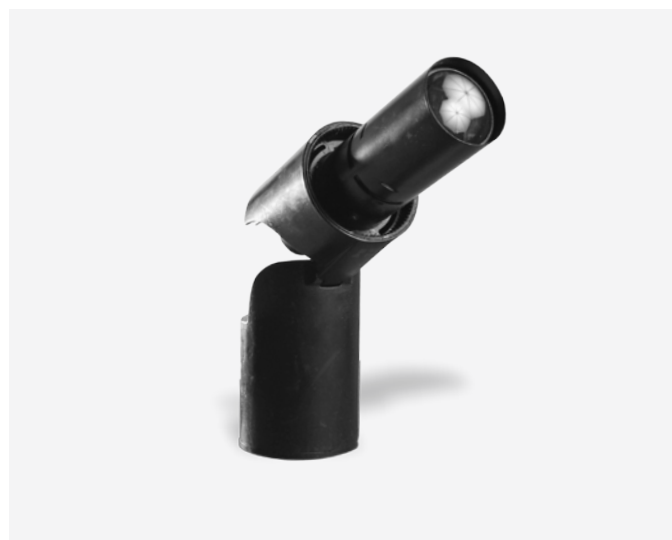

MINI-SAGOMATORE CON DICROICA  
SU BINARIO



FARO A SCARICA PERROQUE  
SU BINARIO – LUCE FREDDA

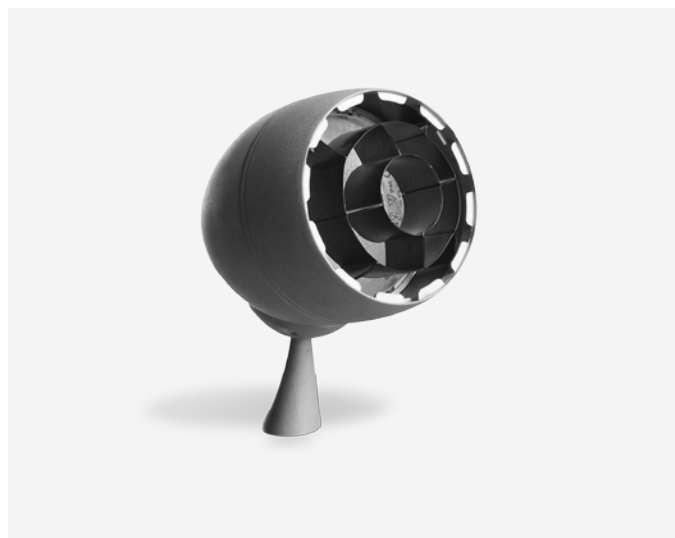

FARO A LUCE TAGLIATA SU BINARIO  
HALOSPOT, R 111



FARO A SCARICA FRONT LIGHT  
SU BINARIO LUCE CALDA



FARO ALOGENO  
SU BINARIO



FARO ALOGENO  
A PINZA CON STELO



FARO ALOGENO CON ALETTE  
SU BINARIO



FARO ALOGENO  
SU BINARIO



FARO ALOGENO  
A PINZA



FARO ALOGENO  
A BASETTA

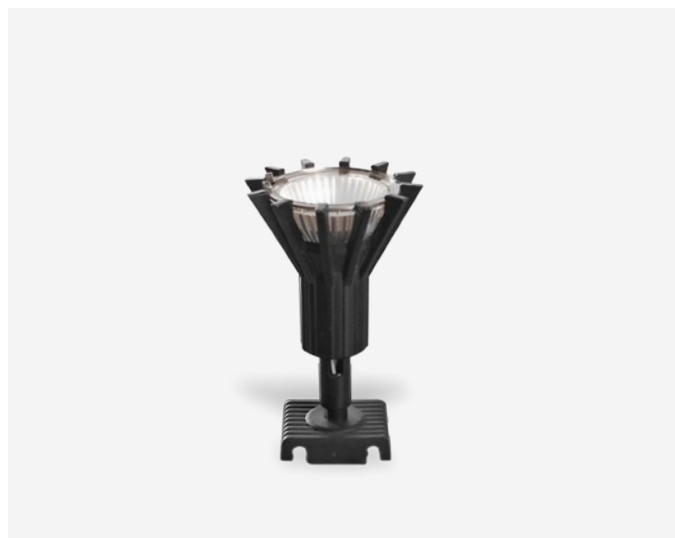

FARETTO DICROICO  
LED – SU STELI  
PER VETRINE



FARO ALOGENO LINEARE  
SU BINARIO



LAMPADA A SOSPENSIONE



FARO ALOGENO – LED  
A BRACCIO



FARO ALOGENO -UFO  
A BRACCIO



FARO A DOPPIA LUCE  
GUZZINI



FARO A SCARICA  
LE CAMPANELLE



CESTELLO A DUE LUCI  
HALOSPOT, R 111



CESTELLO A TRE LUCI  
HALOSPOT, R 111

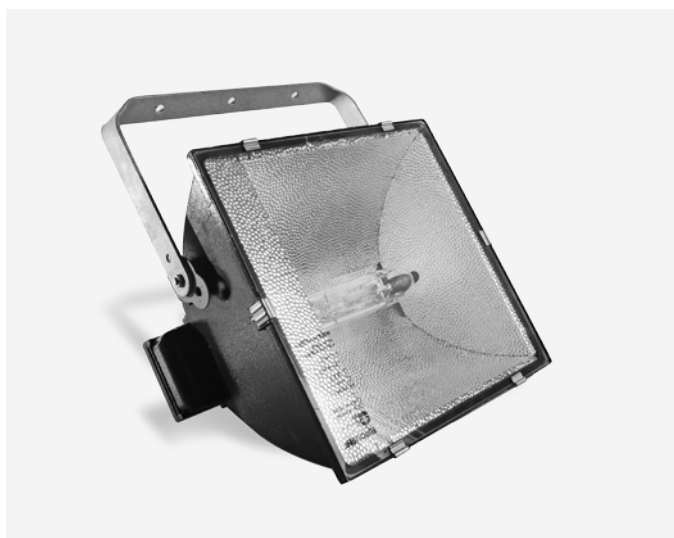

FARO A IODURI METALLICI  
1000 W



FARO A IODURI METALLICI  
400 W



FARO PAR NEL  
650 W



CAMBIACOLORE  
250 W



GOBO PRO A SCARICA  
250 W



SEGUIPERSONA  
1000 W



FARO PC  
2000 W



SAGOMATORE  
2000 W



SAGOMATORE  
1000 W



FARO PC  
1000 W





FARO PC  
500 W



PAR 64 PER ESTERNO  
IP 65



FARO ETC  
650 W



STROBO  
2000 W



FARO IODURI METALLICI  
250 W



FARO ALOGENO  
1000 W



FARO PC  
300 W

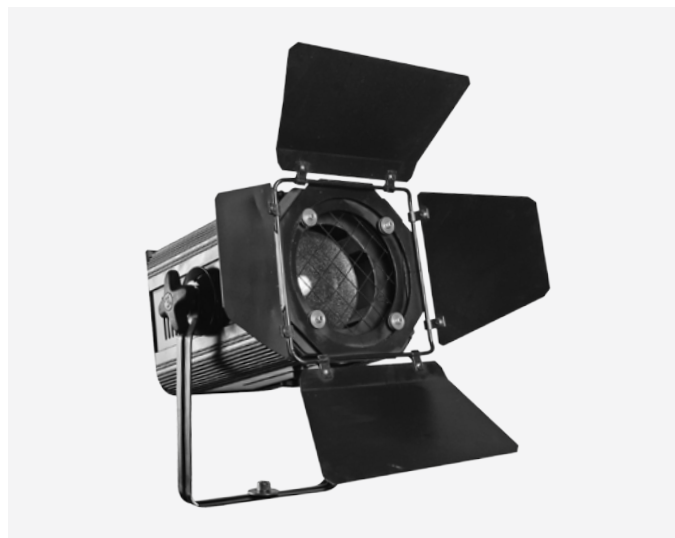

FARO PC ALETTATO

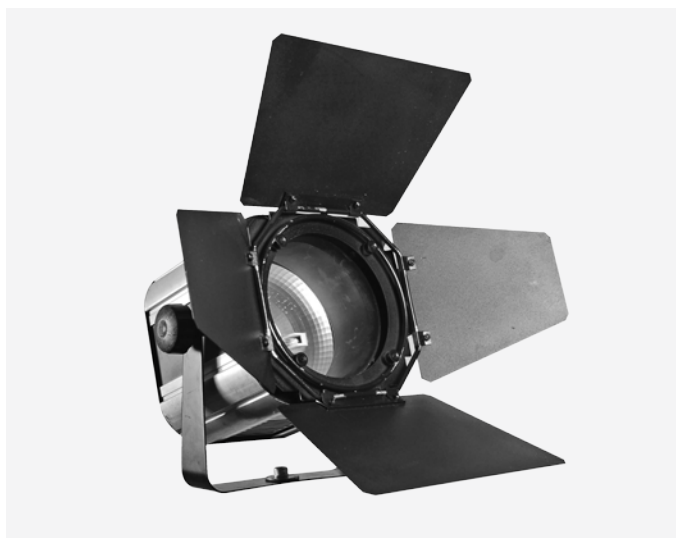

FARO PROSPOT  
300 @ 1000 W



PAR 64 NERO  
1000 W



PAR 64 ALLUMINIO  
1000 W



PAR 64 CORTO  
CON LOMD. SCARICA  
1000 W



PAR 56 NERO  
FREZNER  
300 W



PALLAS LINEAR  
300 W



FARO LASER



PAR 56 A SPECCHIO  
300 W



KANCO LINEAR  
300 W



SUPERLUCCIOLA  
HALOSPOT, R 111



SUPERLUCCIOLA  
CON LAMPADA A LED



FARO A IODURI METALLICI  
ORION 250



FARO A IODURI METALLICI  
PIATTO - ORION 150



FARO A IODURI METALLICI  
QUADRO - ORION 150



TRIAL ONE  
150 W



TUBOR - IODURI METALLICI  
150 W



FANTE - IODURI METALLICI  
150 W



MARTE - IODURI METALLICI  
150 W



LANZINI - IODURI METALLICI  
150 W



BONTE - IODURI METALLICI  
70 W



LE PERROQUET



GRUPPO FIBRE OTTICHE



STRISCIA LED  
IP 65 - ALIMENTATORE



# QUADRI ELETTRICI



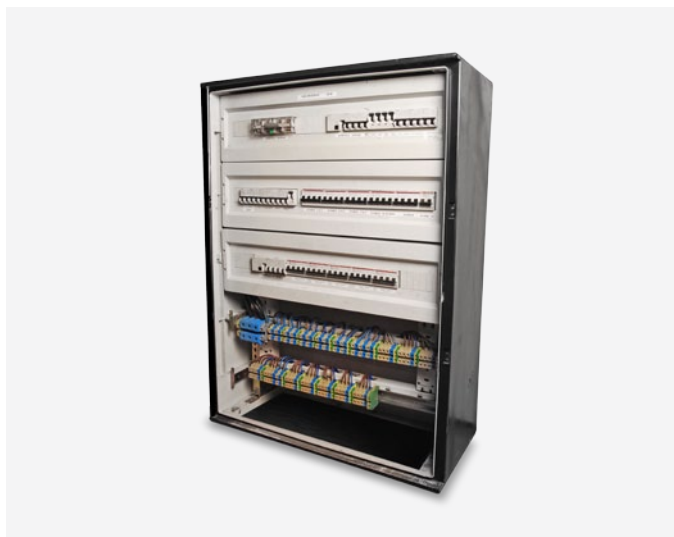

QUADRO ELETTRICO  
100 KW, IP 65



QUADRO ELETTRICO  
18 KW, 6 USCITE WIELAND, IP 54



QUADRO ELETTRICO  
9 KW, 6 USCITE WIELAND, IP 40



QUADRO ELETTRICO  
3 KW, 2 USCITE WIELAND, IP 40



QUADRO ELETTRICO  
18 KW, 6 USCITE WIELAND, IP 40



QUADRO ELETTRICO  
12 KW, 3 USCITE 10A WIELAND, IP 40  
3 USCITE 16A



QUADRO ELETTRICO  
18 KW, 1 USCITA PENT. 16 A, IP 55  
3 USCITE 16A



QUADRO ELETTRICO  
18 KW, 6 USCITE 16 A Europ, IP 55



QUADRO ELETTRICO  
80 KW, IP 65

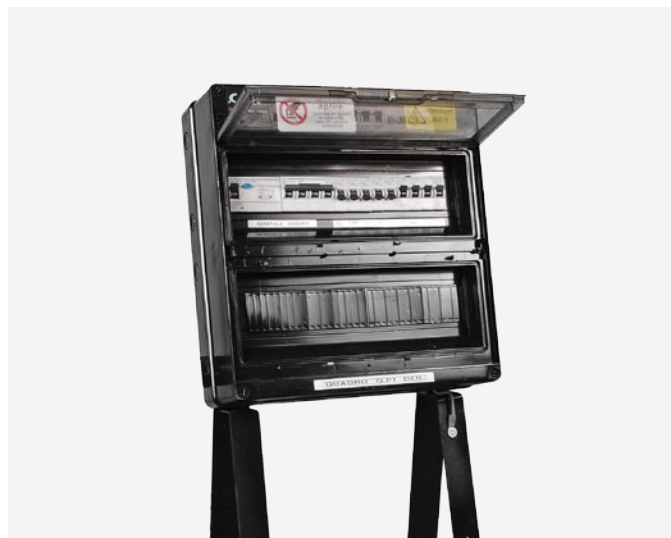

QUADRO ELETTRICO  
36 KW, IP 55



QUADRO ELETTRICO  
140 KW, IP 65



TRASFORMATORE  
PER IMPIANTI A BASSA TENSIONE  
50 @ 300 W



# TRALICCI



TRALICCIO AMERICANA



TRALICCIO DUO



TRALICCIO AMERICANA  
29 x 29 cm



SNODO PER TRALICCI



TRALICCIO CURVO



ACCESSORI TRALICCIO



SNODO A BANDIERA



MOTORE DI SOLLEVAMENTO TRALICCI



CENTRALINA SINCRONIZZATA  
PER MOTORI



CAVI DI AGGANCIAMENTO  
SICUREZZA PER TRALICCI



PEDANA CALPESTABILE



PARANCO PER SOLLEVAMENTI





VARIE



AMPLIFICATORE  
600 + 600 W



RADIO MICROFONO



DIMMER



AMPLIFICATORE  
200 W



CENTRALINA PROGRAMMATTORE  
IMPIANTI LUCE



MEMORIZZATORE  
IMPOSTAZIONI GIOCHI DI LUCE



MIXER AUDIO



DISTRIBUTORE DI AROMI



CASSA ACUSTICA PROFESSIONALE  
TANNOY, 300 W



CASSA ACUSTICA PROFESSIONALE  
LINEAR, 100 W



CASSA ACUSTICA  
TANNOY, 100 W



CASSA ACUSTICA  
PAUDIO, 250 W



GRUPPO CONTINUITA'



TV LCD  
30" - 42" - 50" - 65"



DISTANZIERE PER BINARI  
ELETTRICI



VIDEO PROIETTORE



PLAFONIERA  
200 x 58 cm, IP 55



LAMPADA SLIM  
13 @ 28 W, IP 20



USCITA DI SICUREZZA



EMERGENZA





CATALOGO  
PRODOTTI  
[cdftecnologie.it](http://cdftecnologie.it)